



STARANDDAISY

Premium Baby Walker



Installation and Operational Manual

for safety please read this manual carefully keep it for future reference

THE ASSEMBLY OF WALKER

Included Item

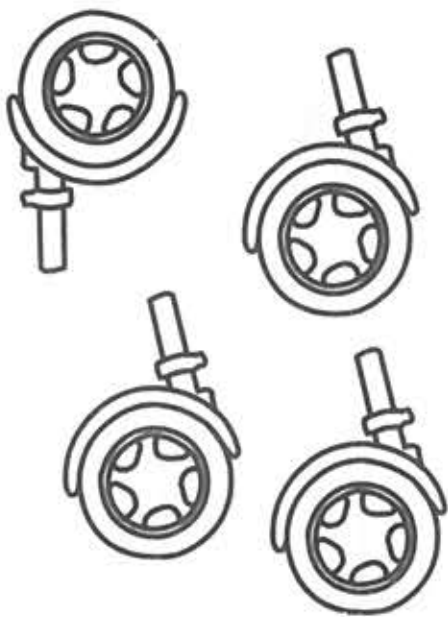
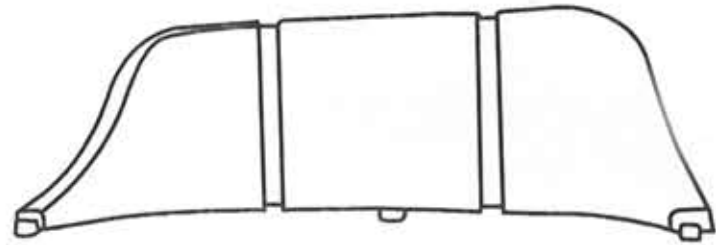
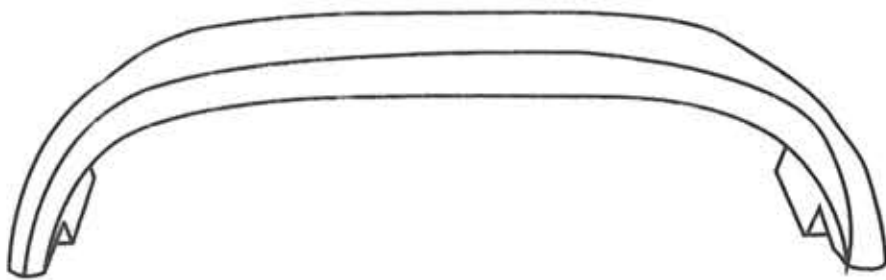
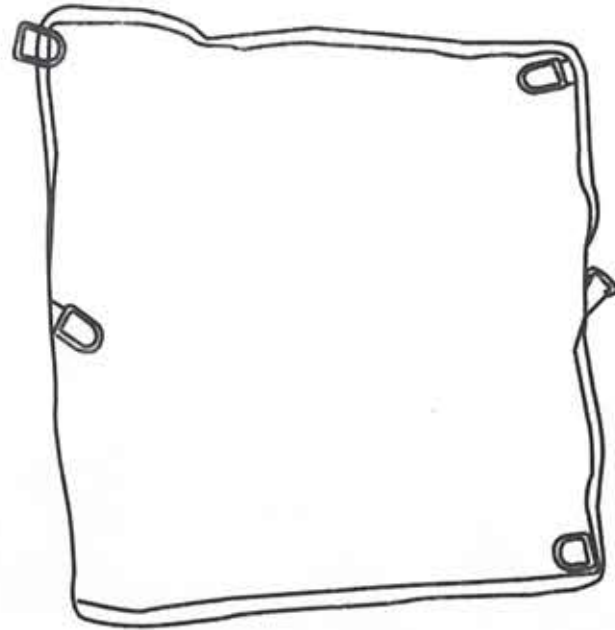
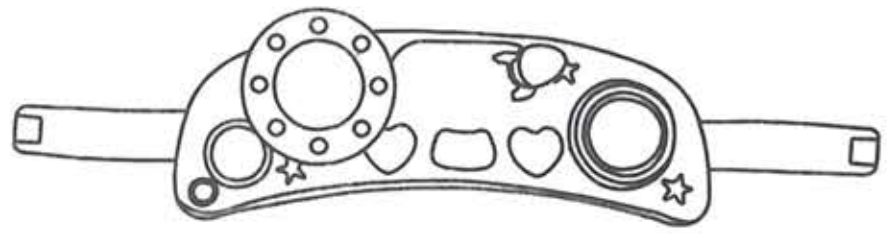
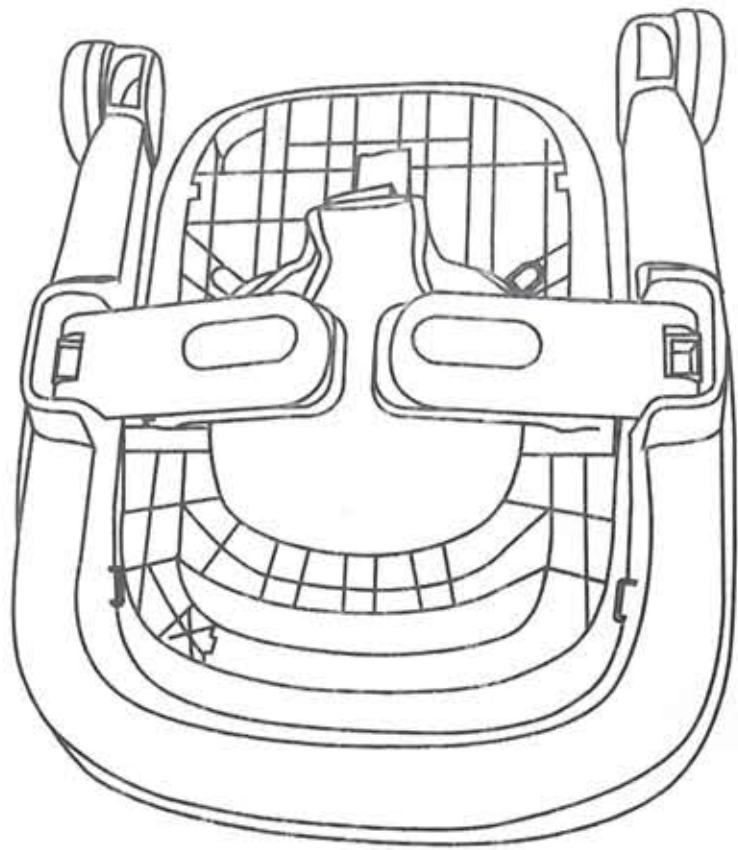

WHEEL INSTALLATION

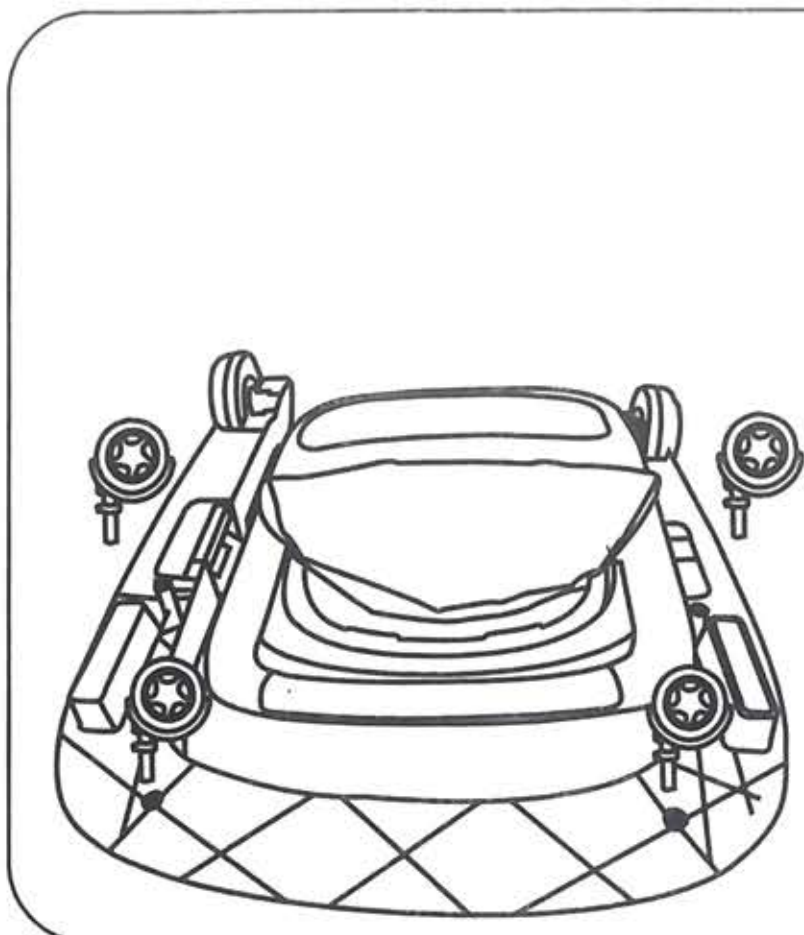

Step 1: Insert 4 wheels at the grooves on the back side of the base frame. Ensure the seal of wheel touches the frame. **If the wheel is too tight, use hair blower to blow some hot air on the groove and then insert the wheel.**

HOW TO UNFOLD

Step 2: Open the two legs smoothly one by one

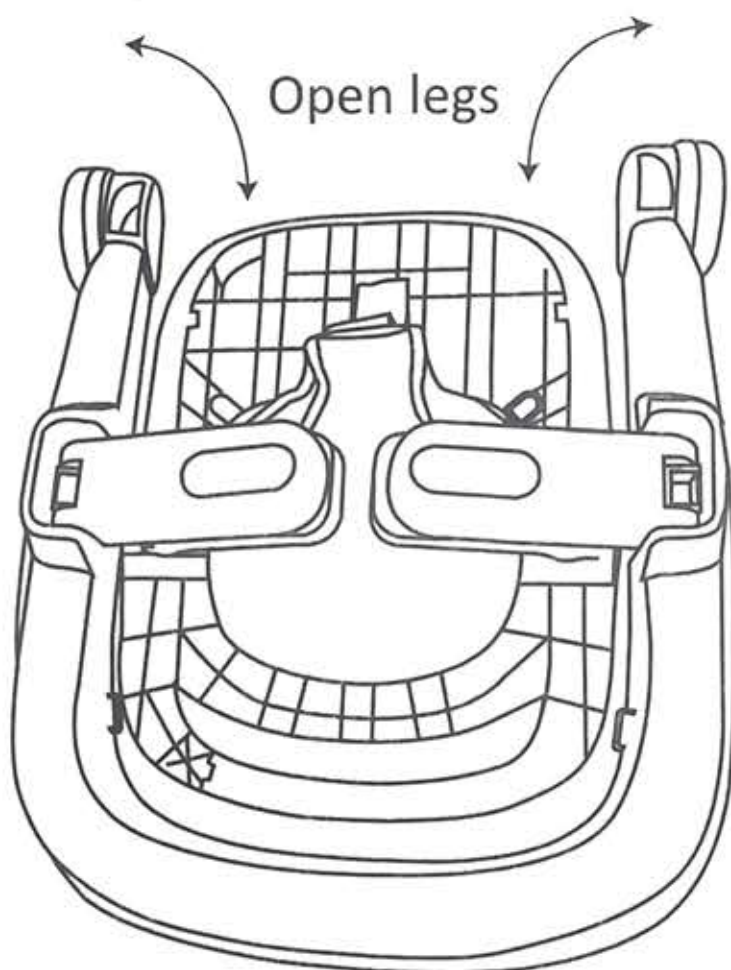

Step 3: Fully pull up the leg together

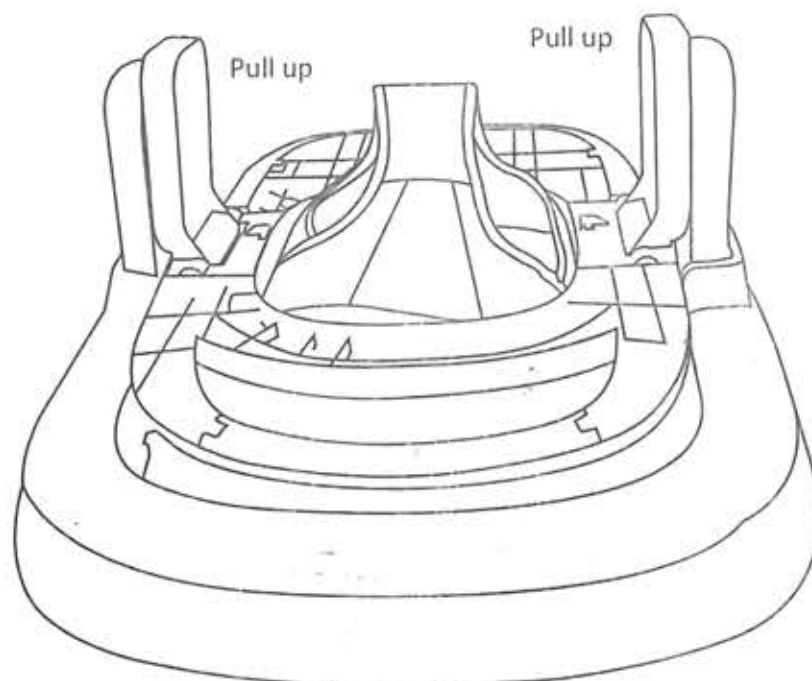

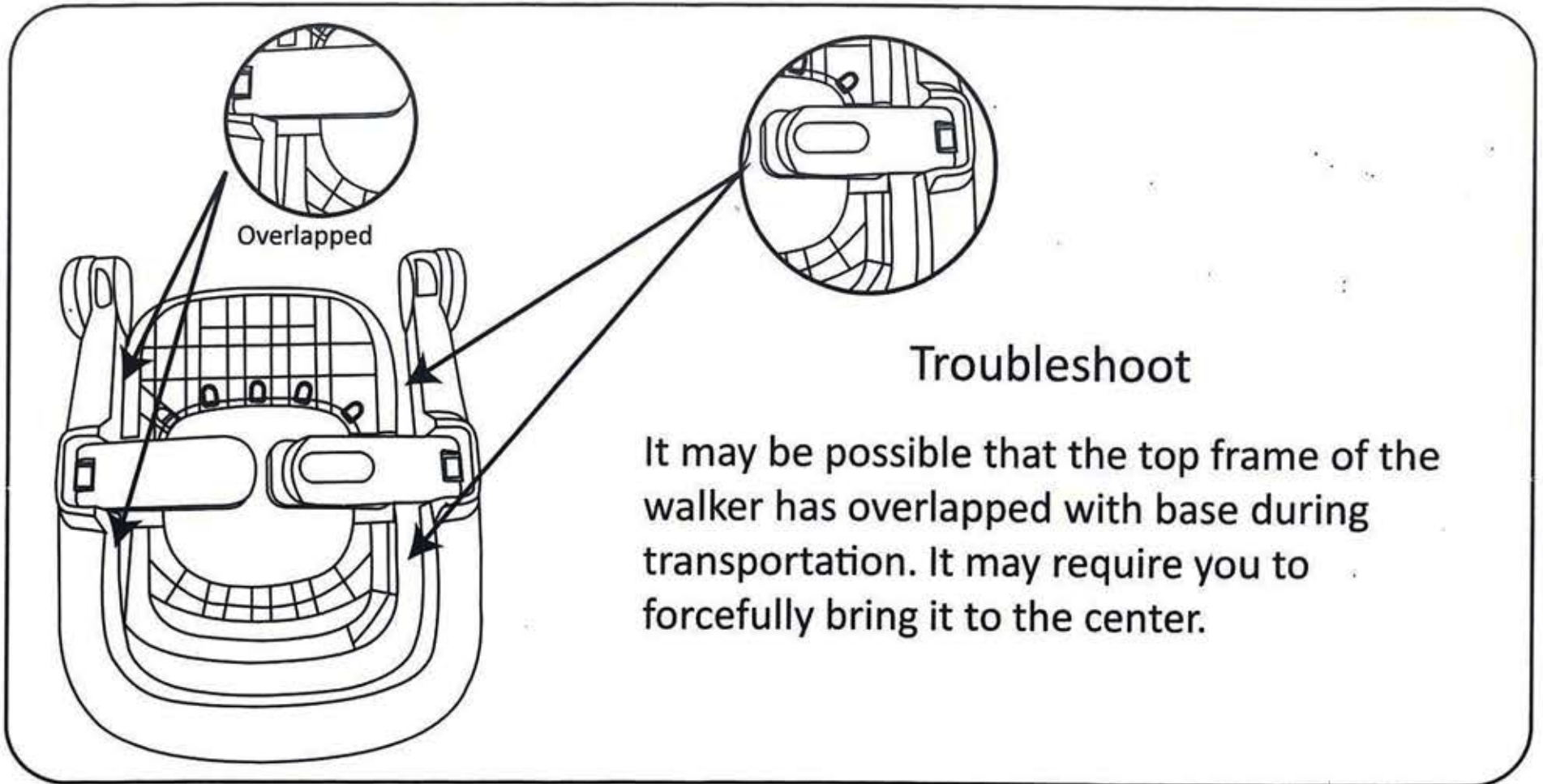

OPEN WALKER SEAT

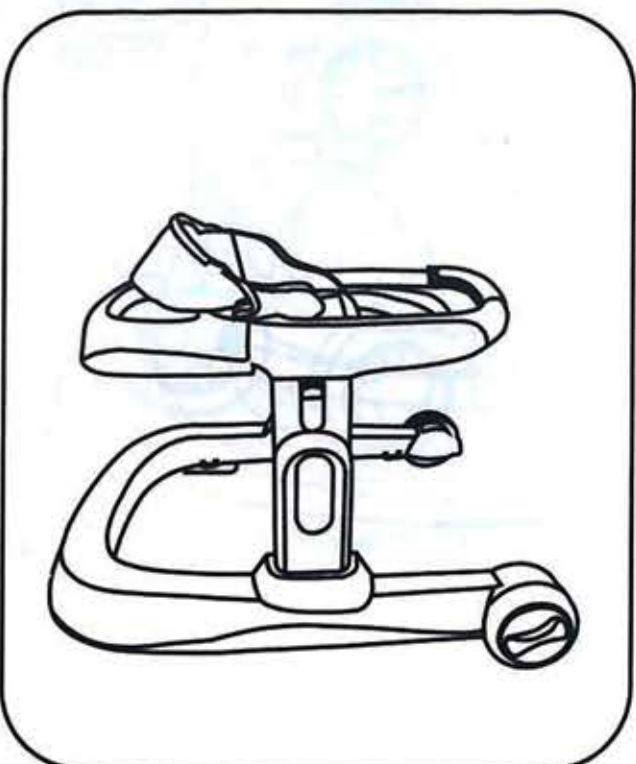
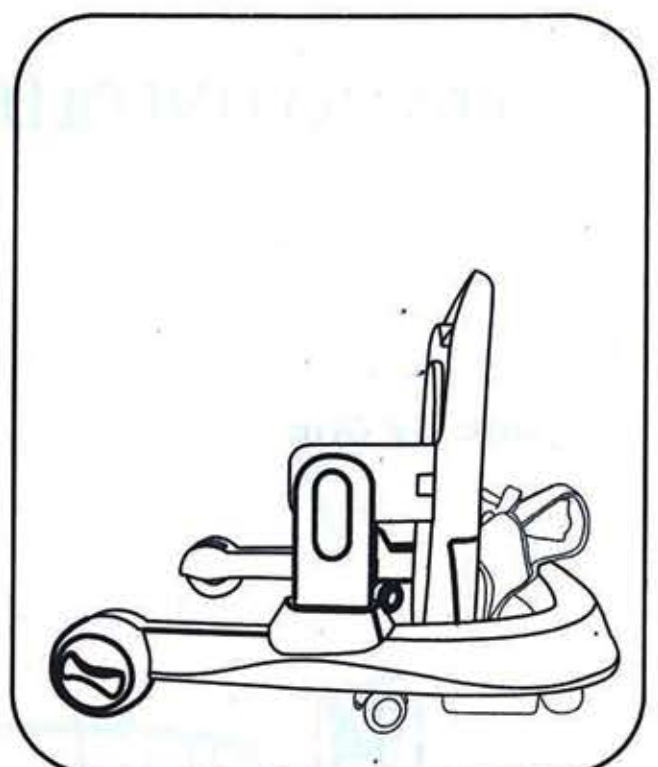
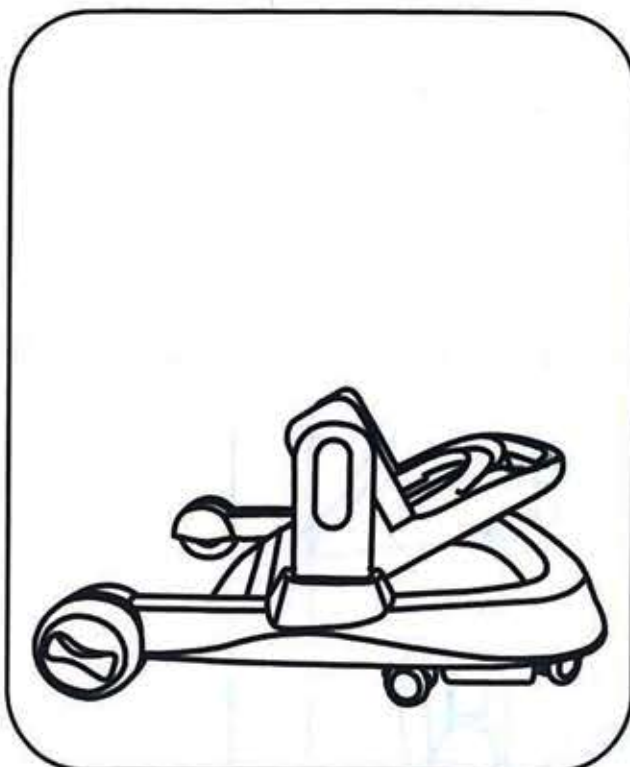
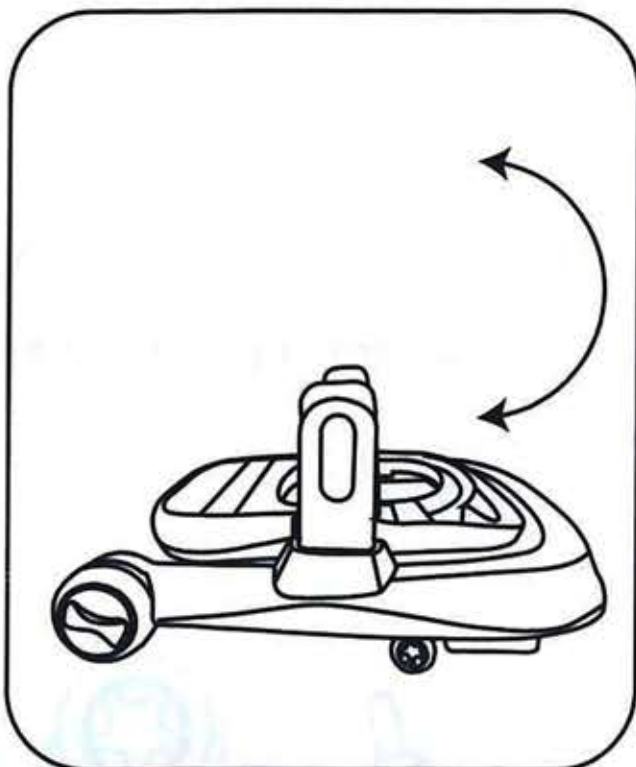

Step 4: After the legs are fully open, rotate the seat and you will hear a click sound once it gets locked at its position.

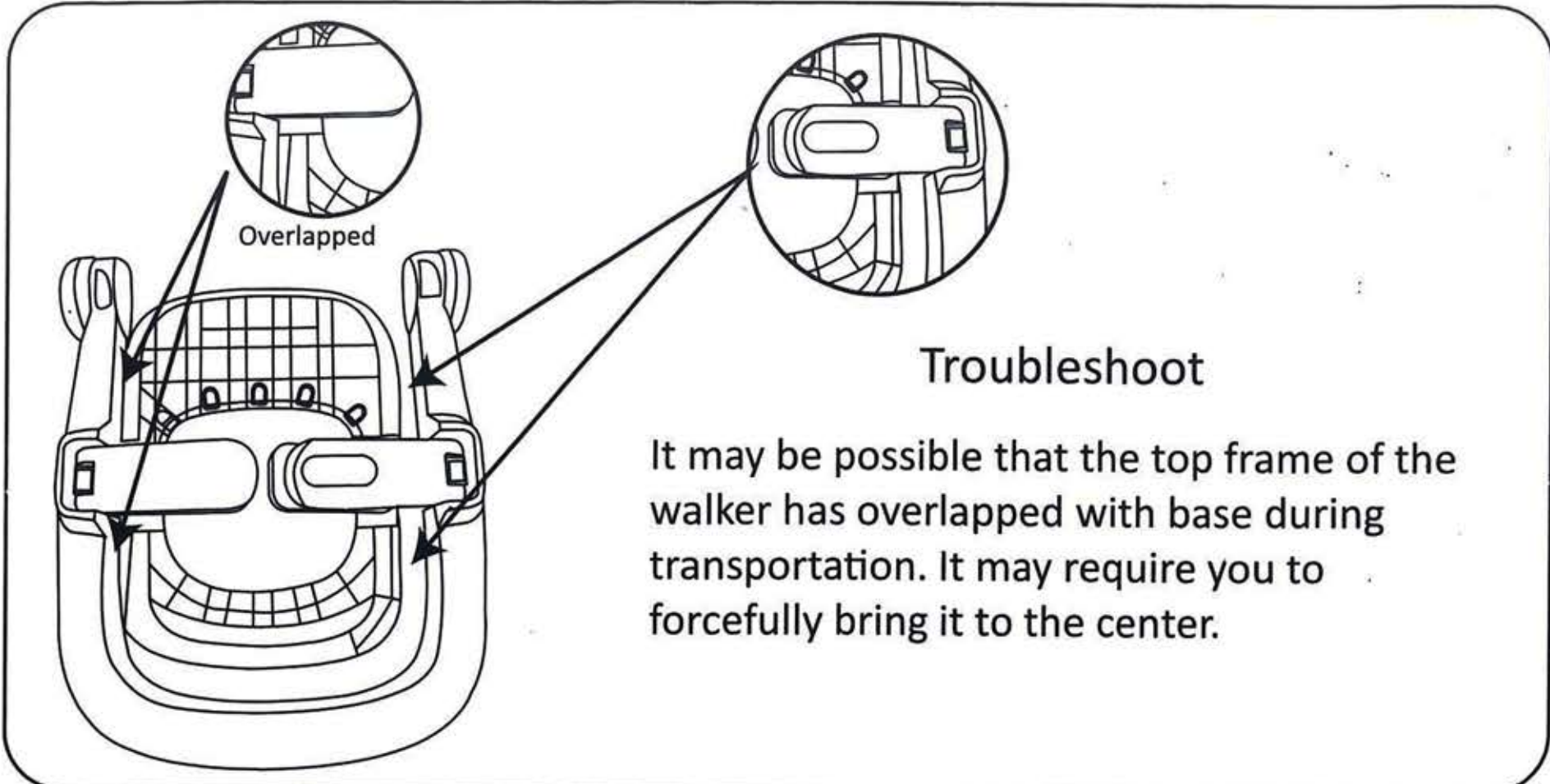

OPEN WALKER SEAT

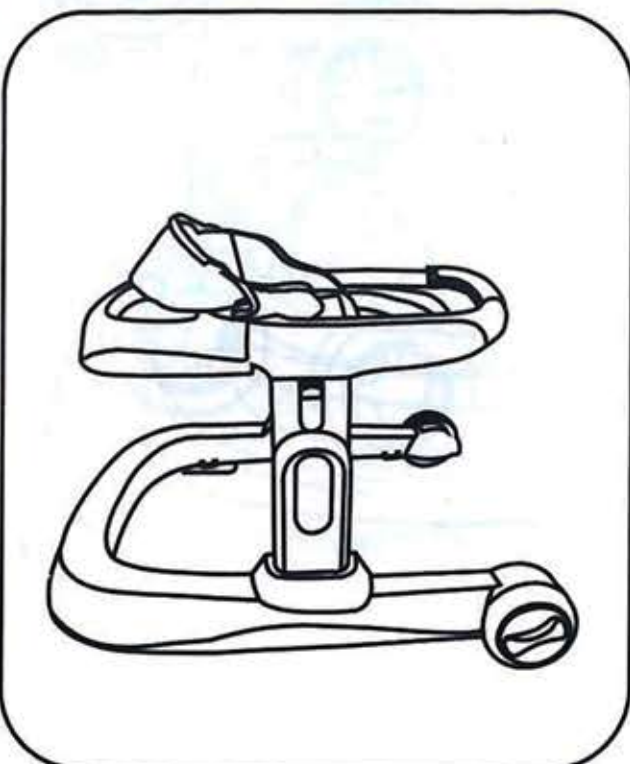
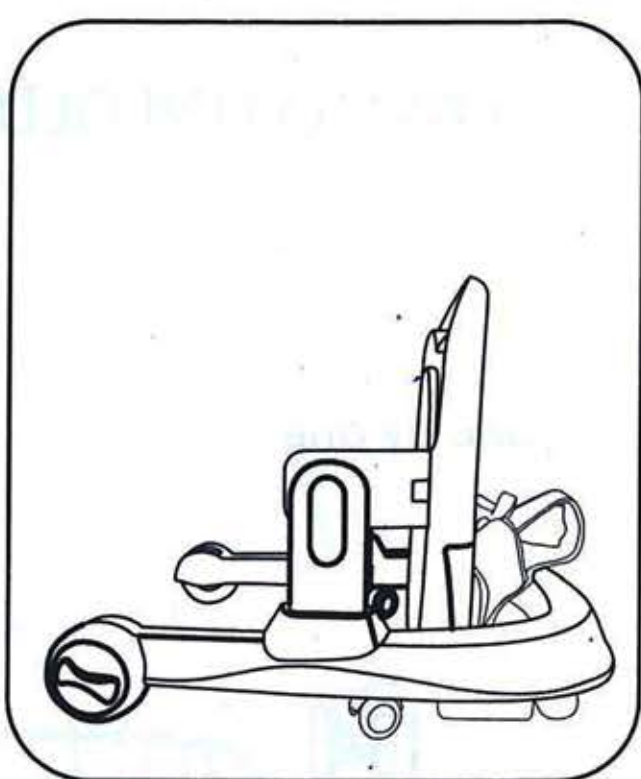
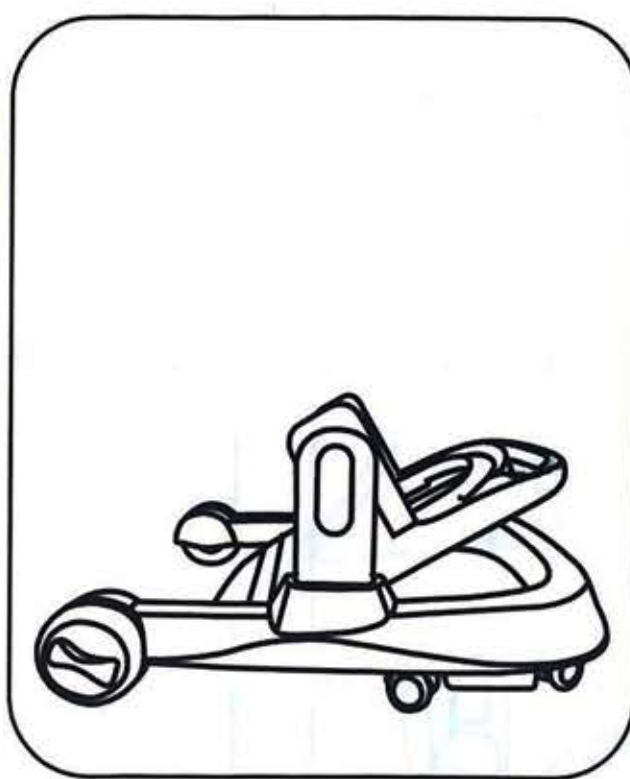
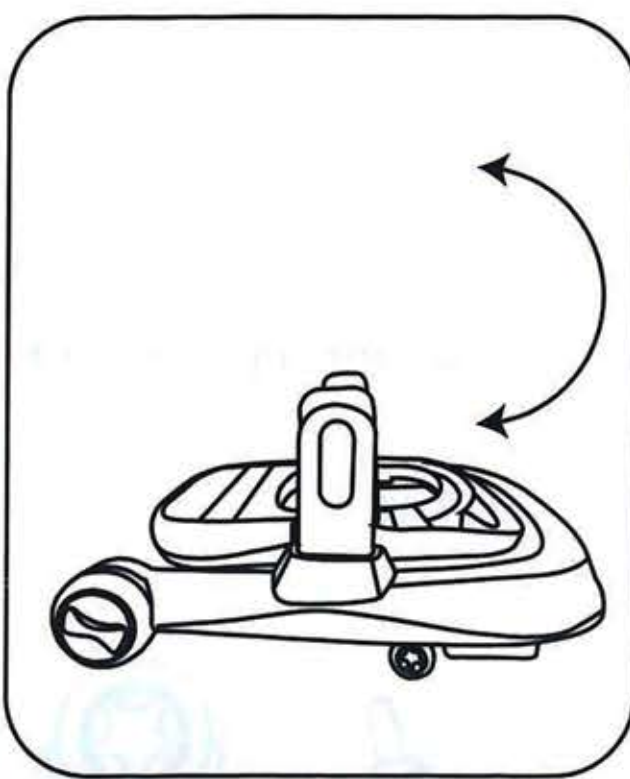

Step 4: After the legs are fully open, rotate the seat and you will hear a click sound once it gets locked at its position.

INSTALL BACK REST

Step 5: Place the back rest and place the seat cushion over it.

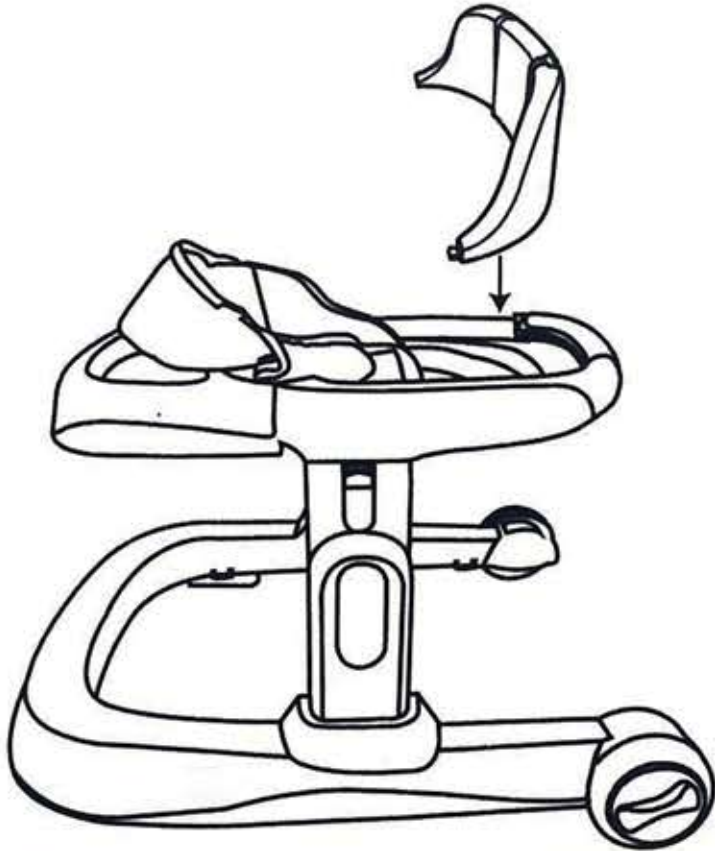

INSTALL SEAT COVER

Step 6: Place the seat cover over the back rest and place all locks in respective grooves.

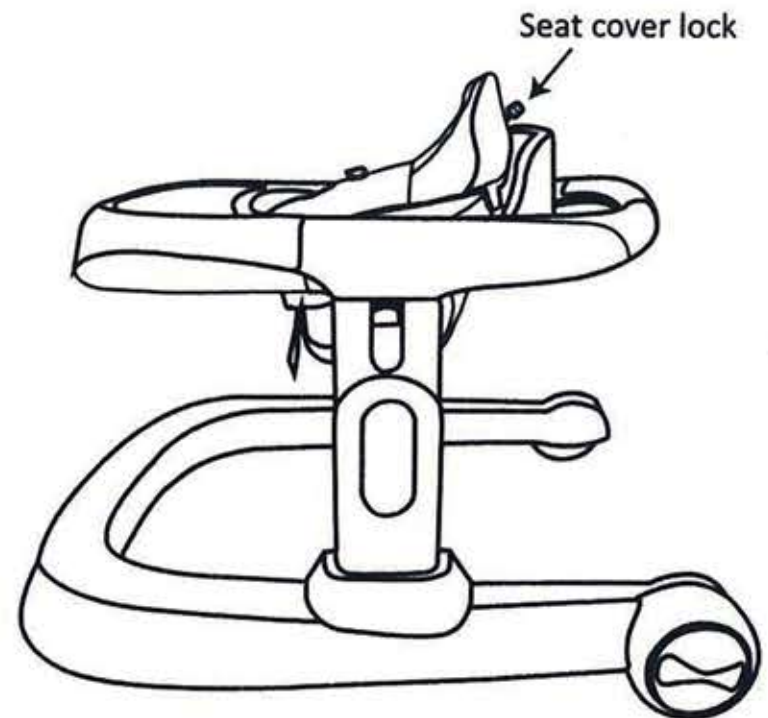

INSTALL REAR BAR

Step 7: Insert the rear bar at the back and push down with the help of hand.

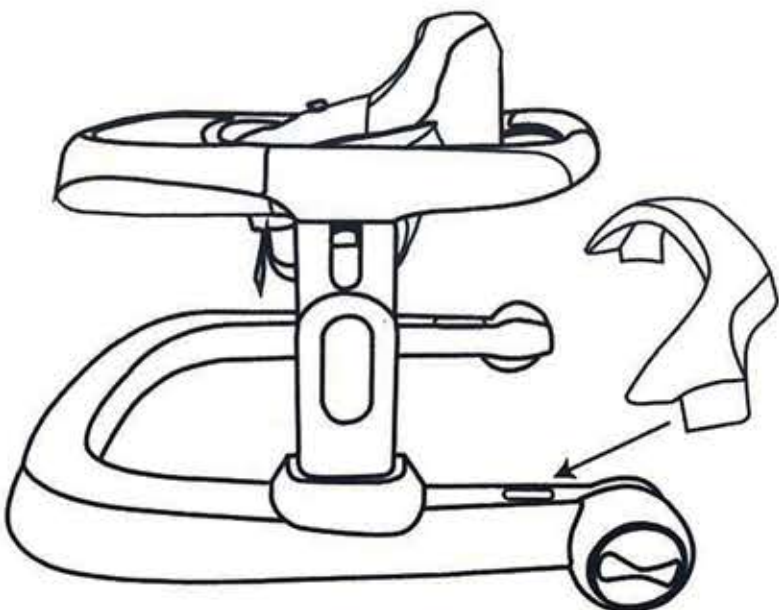

INSTALL TOY BAR

Step 8: Place toy bar on walker and lock the rubber strap at back of the top frame as shown.

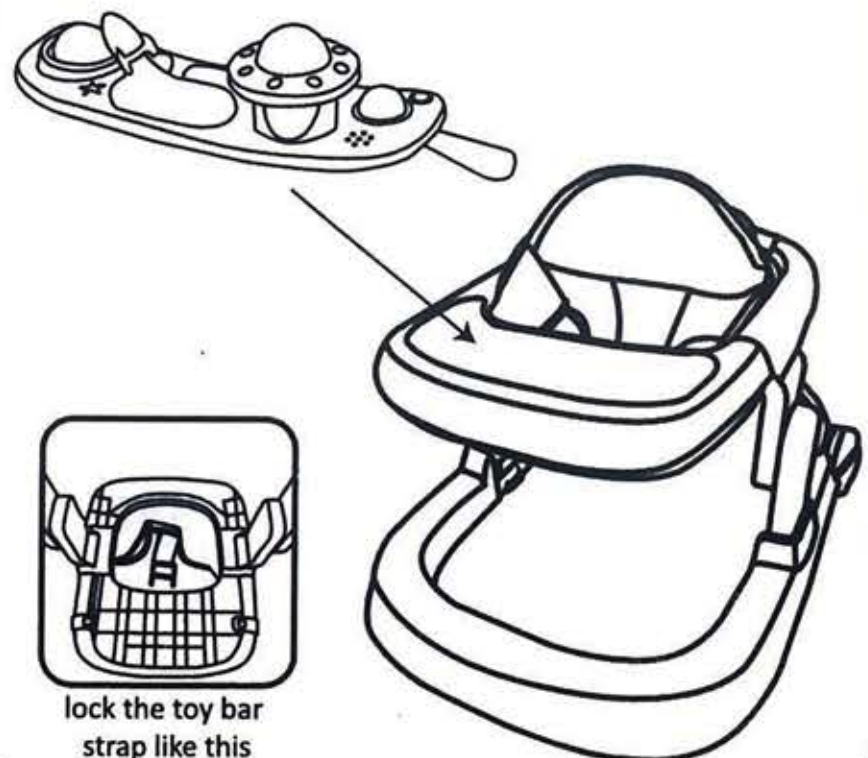



STARANDDAISY

Premium Babycare Products



Scan for Installation video



+91-9872399399



care@staranddaisy.in



www.staranddaisy.in